

HOSONIC ELECTRONIC CO., LTD.

CRYSTAL UNIT SPECIFICATIONS



● PACKAGE

Tape Dimensions(unit : mm)

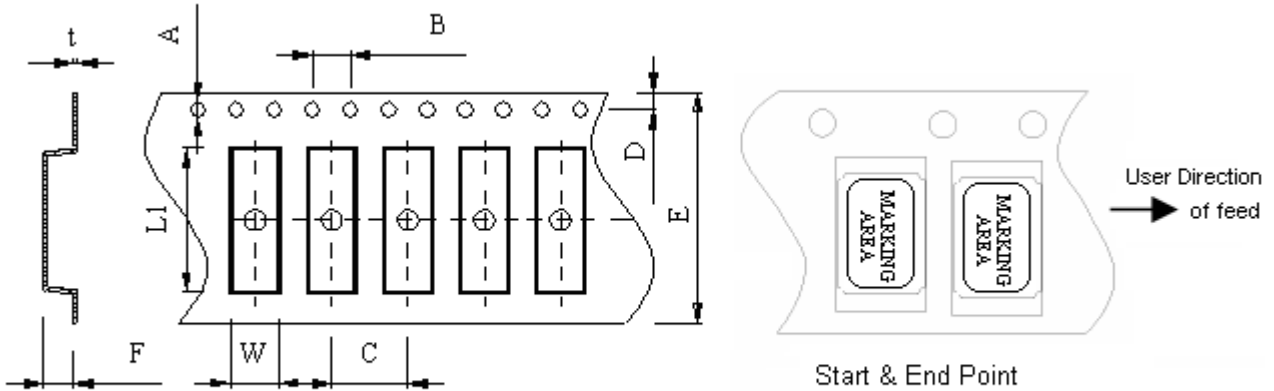

A	B	C	D	E	F	L1	W	t
1.50	4.0	8.0	7.5	16.0	2.0	8.5	5.0	0.3

Reel Dimensions(unit: mm)

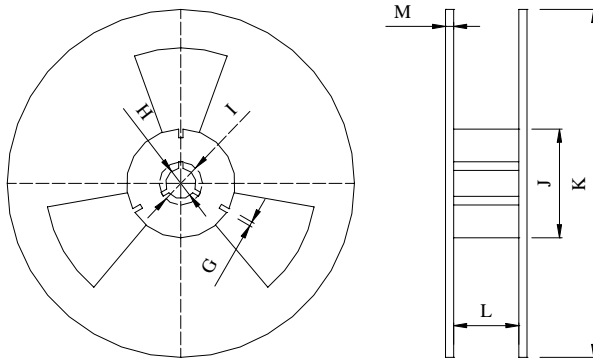

G	H	I	J	K	L	M
2.5	13.5	21.6	60.0	178	17.5	1.6

*1000pcs/Reel

*Specifications are subject to change without notice.

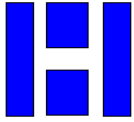

HOSONIC ELECTRONIC CO., LTD.

CRYSTAL UNIT SPECIFICATIONS



Carton Dimension (unit : mm)

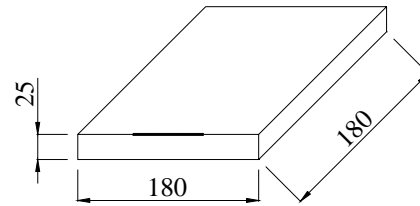
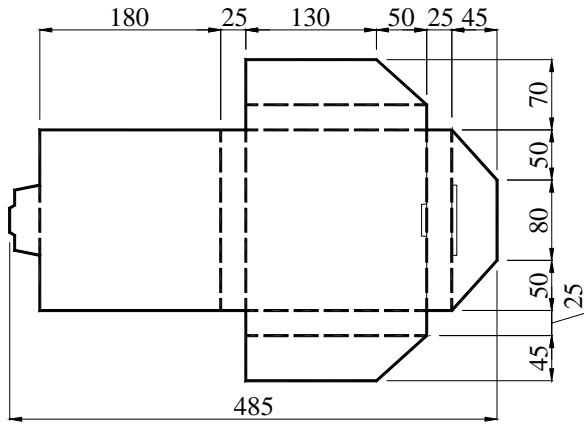

1 reel = 1 Inner box

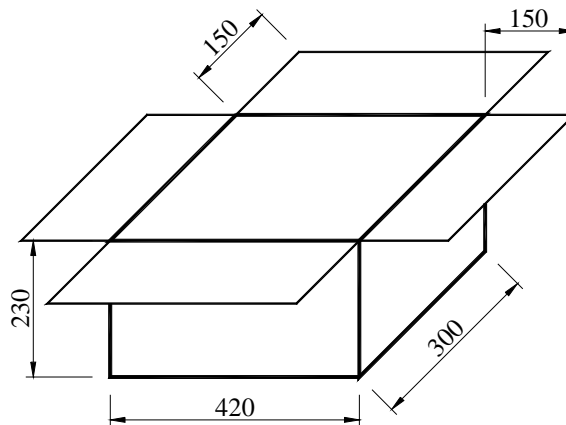
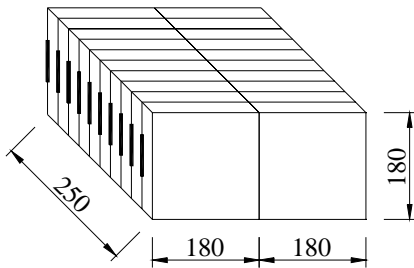

20 Inner boxes = 1 Carton

20kpcs = 1 Carton

*Specifications are subject to change without notice.